

TR-54D

Transceiver Module

Data Sheet



Description

TR-54D is a family of IQRF transceiver modules operating in the 868 MHz and 916 MHz license free ISM (Industry, Scientific and Medical) frequency band. Its highly integrated ready-to-use design requires no external components. Extra low power consumption fits for battery powered applications. SMT mounting and very small dimensions allow space saving.

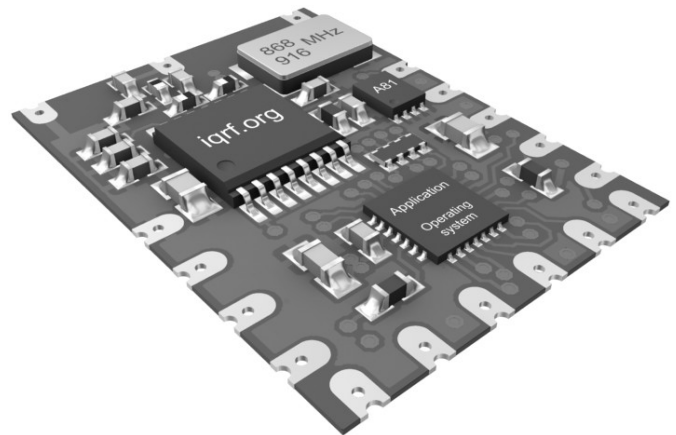

Key features

- Complete solution with operating system, easy to use
- FSK modulation
- Selectable RF band 868 / 916 MHz, multiple channel
- MCU with extended resources, user interrupt capability
- Extra low power consumption, power management modes
- SPI interface supported by OS on background
- Serial EEPROM
- PWM output
- Programmable HW timer
- Battery monitoring
- 18 pins, 11 I/Os, 1 input only
- A/D converter (4 channels), D/A converter
- Analog comparator
- Optional on-board antenna
- Stamp hole pads, SMT mounting, no SIM card compatible
- Very small dimensions

Applications

- Telemetry
- Building automation
- Control & regulation
- Remote data acquisition
- Communication links
- Wireless networks
- RF connectivity in many other areas

Block diagram

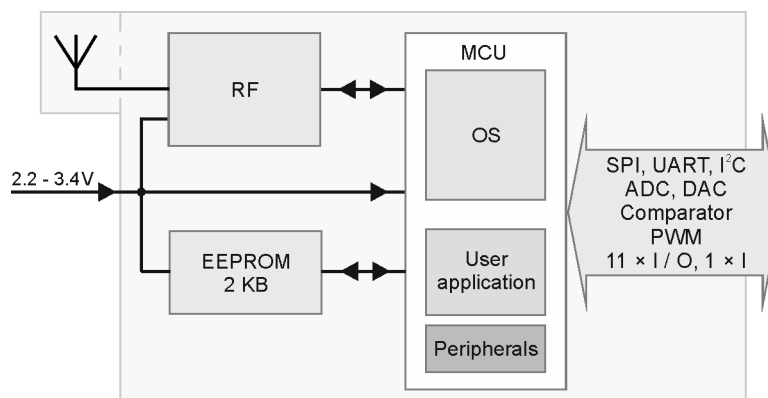

Electrical specifications

(Typical values unless otherwise stated, for brief guidance only)

Supply voltage (V_{CC}) ¹	2.2 V min., 3.4 V max., 3.0 V typ. , stabilized.
Operating temperature	0 °C to +70 °C -40 °C to +85 °C (Industrial) available on request
Supply current	
Sleep mode	380 nA (if all peripherals including MRF49XA disabled ³)
Additional supply current	800 nA (if watchdog enabled) 7.5 µA (if brown-out detection enabled)
Run mode	1 mA (MRF49XA disabled)
Additional supply current	0.6 mA (MRF49XA on)
Rx mode	STD mode: 13 mA LP mode: OS v3.01D: 400 µA, from OS v3.02D: 330 µA XLP mode: OS v3.01D: 35 µA, from OS v3.02D: 25 µA
Tx mode	14 mA – 24 mA (according to RF output power)
Nominal frequency	868.35 MHz or 916.50 MHz (software selectable)
Channels	See IQRF OS User's guide, Appendix 2, Channel maps
RF data modulation	FSK (frequency-shift keying)
RF data transmission bit rate	1.2 kb/s ⁵ , 19.2 kb/s, 57.6 kb/s ⁵ , 86.2 kb/s ⁵
RF sensitivity	Depends on frequency band and bit rate:

	bit rate [kb/s]	1.2 ⁵	19.2	57.6 ⁵	86.2 ⁵
RF sensitivity [dBm]	868 MHz	-110	-104	-99	-92
	916 MHz	-109	-102	-97	-90

RF output power

Programmable in 8 levels (0 – 7), -2.5 dBm/level

level	0	1	2	3	4	5	6	7
[dBm]	-12.5	-10	-7.5	-5	-2.5	0	2.5	5

RF range (TR-54DA)²

Up to 850 m @ 1.2 kb/s⁵
Up to 650 m @ 19.2 kb/s

Input voltage on Q4 to Q15 pins

0 V to V_{CC}

A/D converter

10 bit, 4 inputs (multiplexed S&H, successive approximation)

Input A/D impedance

10 kΩ max.

Dimensions

20.2 mm x 14.9 mm x 3.0 mm (TR-54D)
26.4 mm x 14.9 mm x 3.0 mm (TR-54DA)

Note 1: RF power and other parameters depend on supply voltage. Refer to datasheets of MCU and RF IC used. Test your application with respect to required supply voltage range.

Note 2: RF range strongly depends on module orientation and surroundings.

Note 3: Additional current is consumed when a peripheral is enabled.

Note 4: Depends on interferences.

Note 5: Bit rates different from 19.2 kb/s are preliminary, for experimental purpose only.

Users have to ensure observing local provisions and restrictions relating to the use of short range devices by software, e.g. the CEPT ERC/REC 70-03 Recommendation and subsequent amendments in EU.

Absolute maximum ratings

Stresses above the following values may cause permanent damage to the device. Exposure to maximum rating conditions for extended periods may affect device reliability.

Supply voltage (V_{CC})	4 V
Voltage on Q4 to Q15 pins	-0.3 V to ($V_{CC} + 0.3 V$)
Storage temperature	-50 °C to +100 °C
Ambient temperature under bias	-40 °C to +85 °C

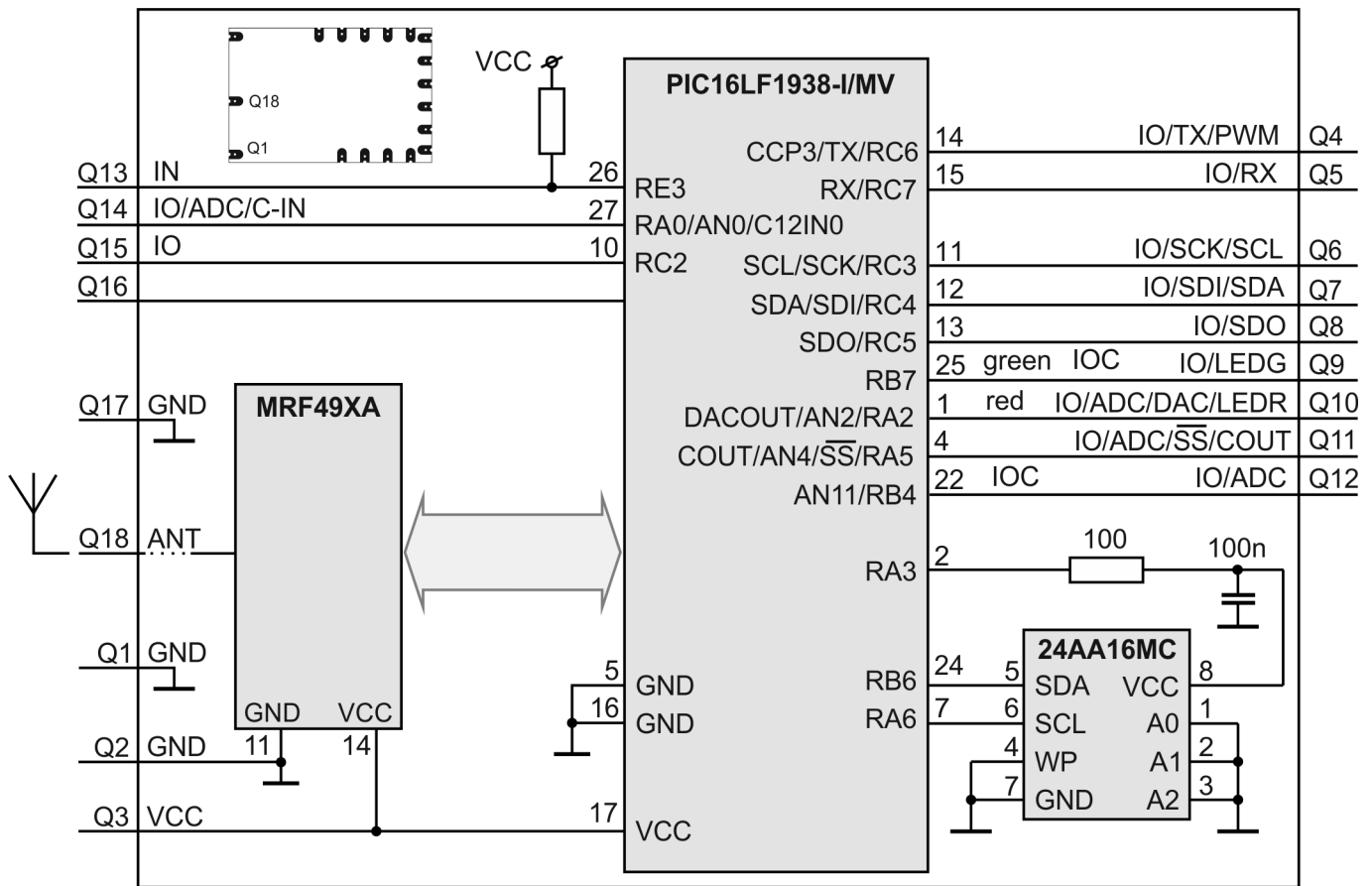
Simplified schematic

Basic parts

Part	Type	Manufacturer	Note
MCU	PIC16LF1938-I/MV	Microchip	
RF IC	MRF49XA	Microchip	
EEPROM	24AA16/MC	Microchip	2 kB

For more information refer to respective datasheets.

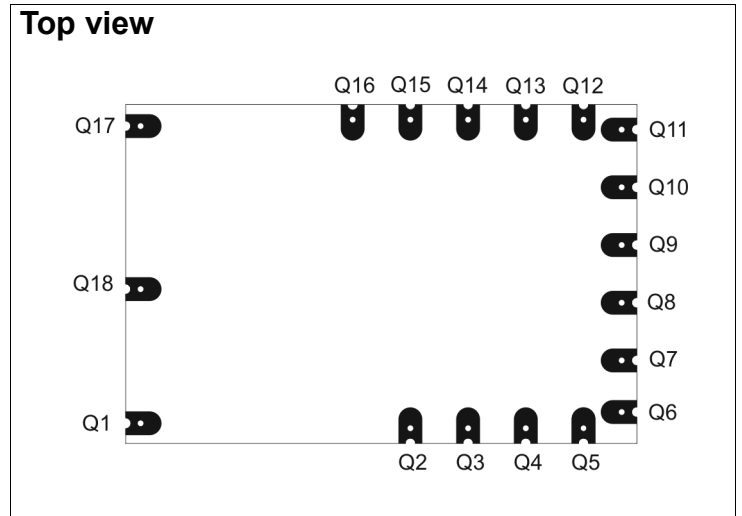
Pin	Name	Description
Q1 ⁶	GND	Ground
Q2	GND	Ground
Q3	VCC	Power supply voltage
Q4	IO/ TX /PWM	
	RC6	General I/O pin
	TX	UART TX
	CCP3	PWM output
Q5	IO/RX	
	RC7	General I/O pin
	RX	UART RX
Q6	IO/SCK/SCL	
	RC3	General I/O pin
	SCK	SPI clock input
	SCL	I ² C clock
Q7	IO/SDI/SDA	
	RC4	General I/O pin
	SDI	SPI data
	SDA	I ² C data
Q8 ⁷	IO/SDO	
	RC5	General I/O pin
	SDO	SPI data out
Q9	IO/ LEDG	
	RB7	General I/O pin, programmable pull-up and interrupt/wake-up on change (IOC)
	LED1	LEDR supported by OS
Q10	IO/ADC/ LEDR	
	RA2	General I/O pin
	AN2	Analog A/D input
	LED2	LEDR supported by OS
	DACOUT	D/A converter output
Q11	IO/ADC/-SS/COUT	
	RA5	General I/O pin,
	AN4	Analog A/D input
	-SS	SPI Slave select
	C2OUT	Comparator output
Q12	IO/ ADC	
	RB4	General I/O pin, programmable pull-up and interrupt/wake-up on change (IOC)
	AN11	Analog A/D input
Q13	IN	
	RE3	General input only pin
Q14	IO/ADC/C-IN	
	RA0	General I/O pin
	AN0	Analog A/D input
	C12IN0	Comparator -input
Q15	IO	
	RC2	General I/O pin
Q16	-	Do not use, leave unconnected
Q17 ⁶	GND	Ground
Q18 ⁶	ANT	Antenna



Note 6: Not implemented for TR-54DAx.

Note 7: This pin is used as output during initial ~250 ms boot-up to recognize programming mode.

There are no on-board protection series resistors on I/O pins. It is recommended to use 200 Ω series resistors on each pin.

Figure 1: Relative RF range vs. level for the `setTXpower(level)` function. Refer to IQRF OS Reference guide.

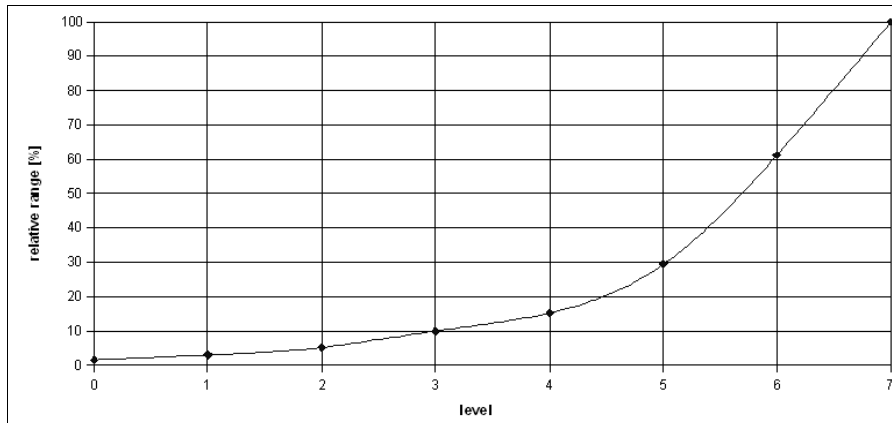

Figure 2: Relative RF range vs. level for the `checkRF(level)` function. Refer to IQRF OS Reference guide.

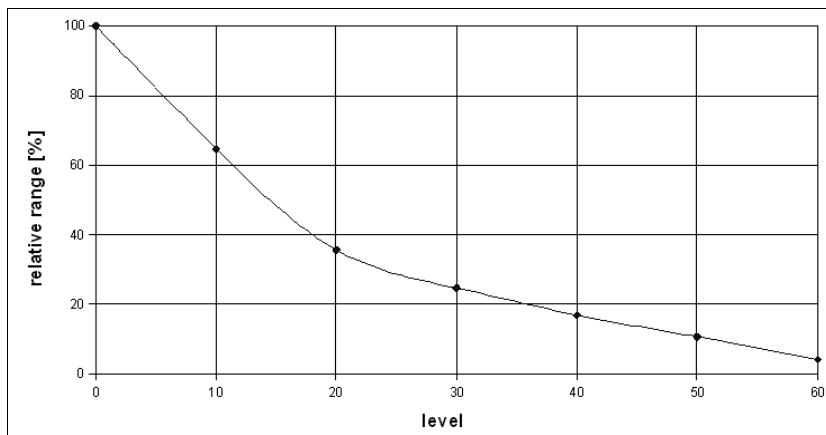
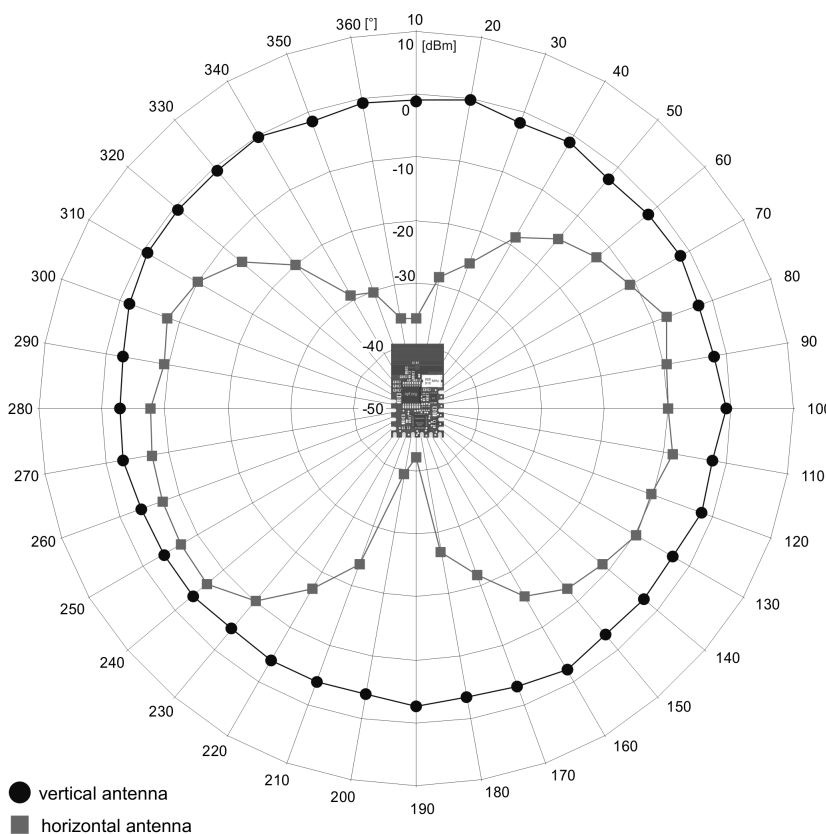
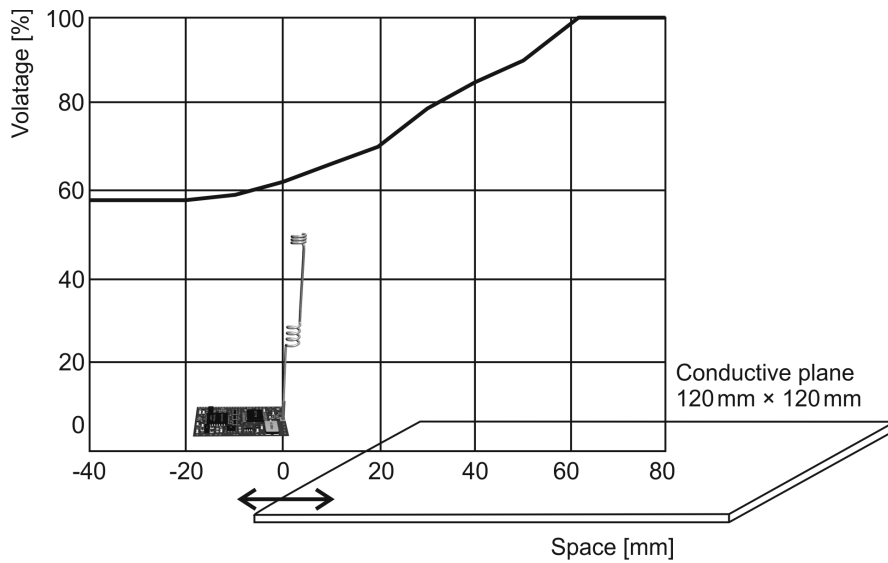
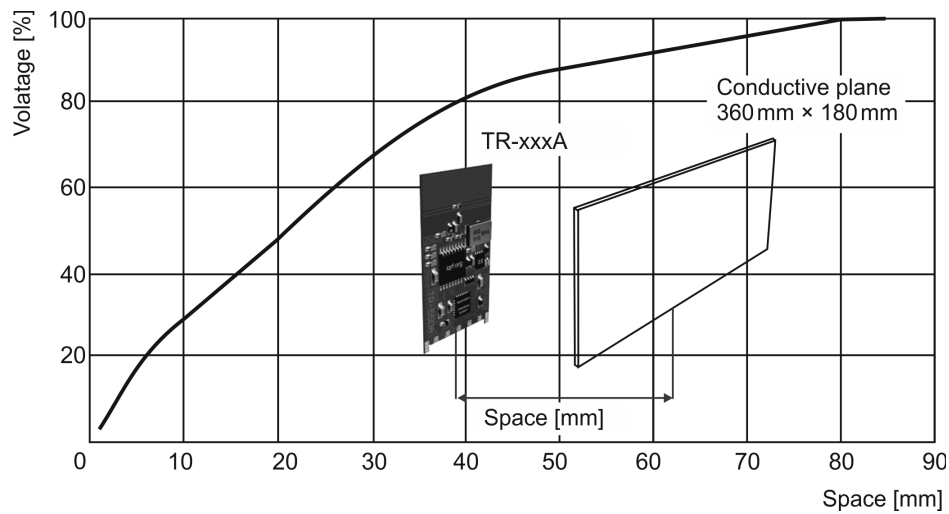

Figure 3: TR-54DA relative RF range vs. antenna orientation (radiation patterns)



Relative decrease of RF input signal vs. antenna edge spacing to conductive areas

Conductive areas close to the antenna must be avoided.

Figure 4: Perpendicular arrangement**Figure 5: Parallel arrangement**

Mechanical drawings

TR-54D

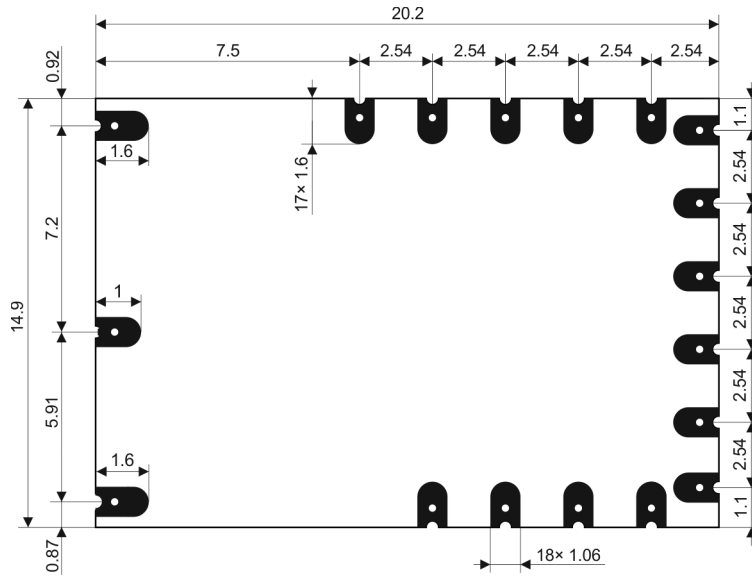

TR-54DA

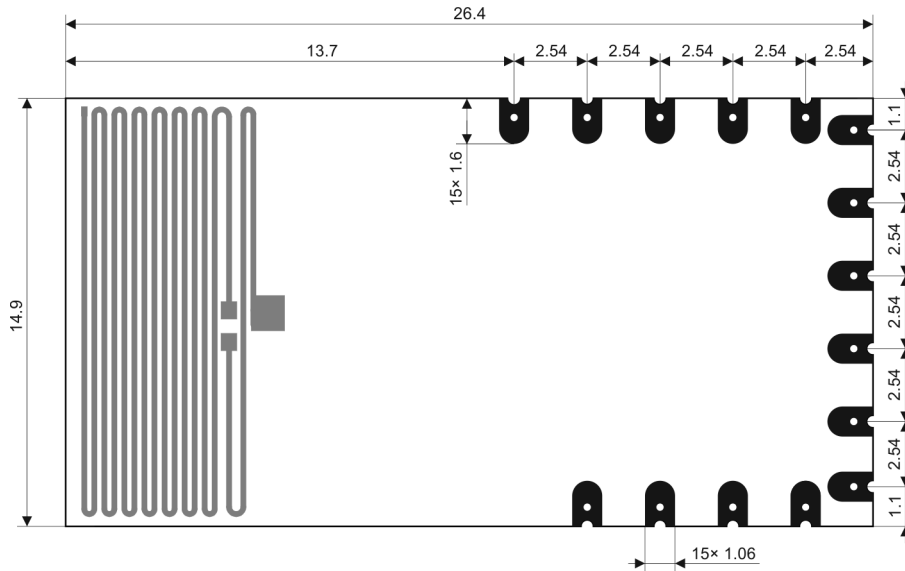

Top view, units: mm

Application

Recommended PCB layout for user application

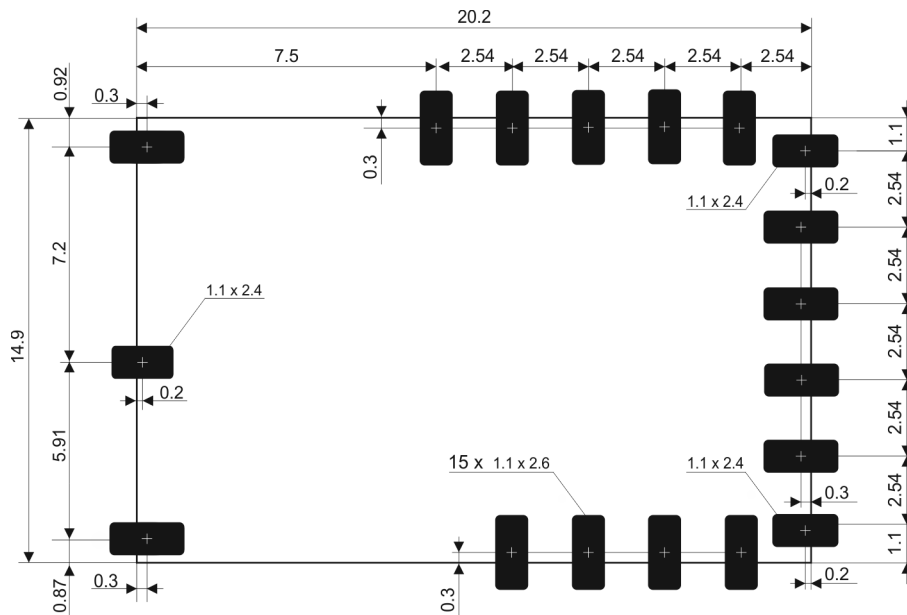

Top view, units: mm

Assembly

For proper mounting of surface mount TR modules and avoiding damage during solder reflow assembly the IPC/JEDEC J-STD-020C standard must be observed. The parts must be baked dry according to IPC/JEDEC J-STD-033C, MSL 4 before reflow soldering. For reflow profile and details refer to the AN010 Application note – SMT mounting of IQRF TR modules.

Caution: TR-54Dx must not be plugged in a SIM connector with metallic holder.

Development

Solderless prototyping

For flexible development the TR-DB-54DA kit is intended. It is a removable SIM-compatible device containing the TR-54DA which can be plugged in the SIM connector in user equipment or in an appropriate IQRF development kit, e.g. DK-EVAL-04. Refer to the TR-DB-54DA User's guide for details.

Operating system

See IQRF OS User's guide and IQRF OS Reference guide.

Software

See Application examples on www.iqrf.org website.

Programming

There are two possibilities to upload a user program in TR-54Dx modules soldered in an application:

- For wired upload using the CK-USB-04 programmer the KON-PGM-01 adapter is intended. See the KON-PGM-01 User's guide for details.
- RFPGM – RF programming™ (wireless upload). See the IQRF OS User's guide, chapter *RF programming*.

Product information

Ordering codes

TR - 5 4 D **A**

antenna options: **nil** - soldering pad-hole (no antenna, no U.FL connector)
 A - PCB antenna

Type	Antenna option	Serial EEPROM
TR-54D	Soldering pad-hole	2 kB
TR-54DA	Internal PCB antenna	2 kB

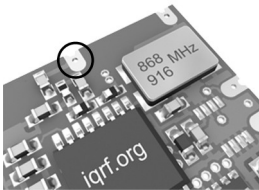

TR-54D

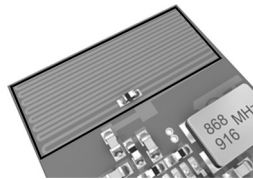

TR-54DA

Document history

- 121001 Chapter *Assembly* added, chapter *Development* slightly extended. Information about D/A converter, analog comparator, PWM, IOC and pull-ups added. Bug in TR-54DA mechanical drawing fixed.
- 120831 Power consumption for OS v3.02D added.
- 120810 Electrical specification slightly precised. Some minor improvements.
- 120703 Chapter *Programming* changed.
- 120622 Block schematics and Figure 5 added. Chapter *Programming* precised. Figures *Dimensions* and *Recommended PCB layout* precised.
- 120601 Electrical specifications updated. Chapters *Pin description*, *Development* and *Programming* updated. Recommended PCB layout added. All TR-54Dx are equipped with serial EEPROM.
- 120425 Changes in pins, dimensions and antenna options. RF range specified. Fig. 4 added. Schematics simplified. Preliminary.
- 111011 Preliminary.

Sales and Service

Corporate office

MICRORISC s.r.o., Delnicka 222, 506 01 Jicin, Czech Republic, EU
Tel: +420 493 538 125, Fax: +420 493 538 126, www.microrisc.com

Partners and distribution

Please visit www.iqrf.org/partners

Quality management

ISO 9001 : 2009 certified

*Complies with ETSI directives EN 30279 V.1.2.1:99, ETS 30683:97, ETSI EN 301489-1:00,
ETSI EN 300220-1:00, ETSI EN 300390-2V.1.1.1:00*

Complies with FCC directives FCC CFR, Title 47, Part 15, Section 15.209, FCC CFR, Title 47, Part 15, Section 15.249

Complies with Directive 2002/95/EC (RoHS)



Trademarks

*The IQRF name and logo are registered trademarks of MICRORISC s.r.o.
PIC, SPI, Microchip, RFM and all other trademarks mentioned herein are property of their respective owners.*

Legal

All information contained in this publication is intended through suggestion only and may be superseded by updates without prior notice. No representation or warranty is given and no liability is assumed by MICRORISC s.r.o. with respect to the accuracy or use of such information.

Without written permission it is not allowed to copy or reproduce this information, even partially.

No licenses are conveyed, implicitly or otherwise, under any intellectual property rights.

The IQRF products utilize several patents (CZ, EU, US)

On-line support: support@iqrf.org



Smarter wireless. Simply.