

TR-53B

Transceiver Module

Data Sheet



Simple way to smarter wireless solutions

Description

TR-53B is a family of IQRF transceiver modules operating in the 868 MHz and 916 MHz license free ISM (Industry, Scientific and Medical) frequency band. Its highly integrated ready-to-use design requires no external components. The microcontroller with built-in operating system, excellent development support, integrated LDO regulator and serial EEPROM dramatically reduce time of application development. Ultra low power consumption predetermines these modules for use in battery powered applications.

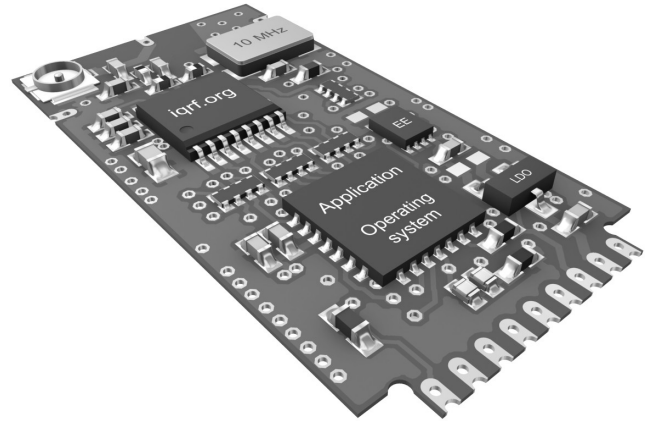

Applications

- Telemetry
- Building automation
- Wireless control & regulation
- Access control
- Remote data acquisition
- Communication links
- RF connectivity in many other areas

Key features

- Complete solution with operating system, easy to use
- Extended RF power, FSK modulation, selectable RF bit rate
- Selectable band 868 / 916 MHz, multiple channel
- MCU with extended Flash memory, additional serial EEPROM
- Ultra low power consumption, power management modes
- SPI interface supported by OS on background
- Battery monitoring
- +3 V LDO regulator output, 2 LEDs
- Up to 7 I/Os, up to 3 analog inputs (A/D)
- Mounting: SIM connector, SMT or through-slot soldering
- Coaxial antenna connector (optional)
- On-board antenna (optional)

Simplified schematics

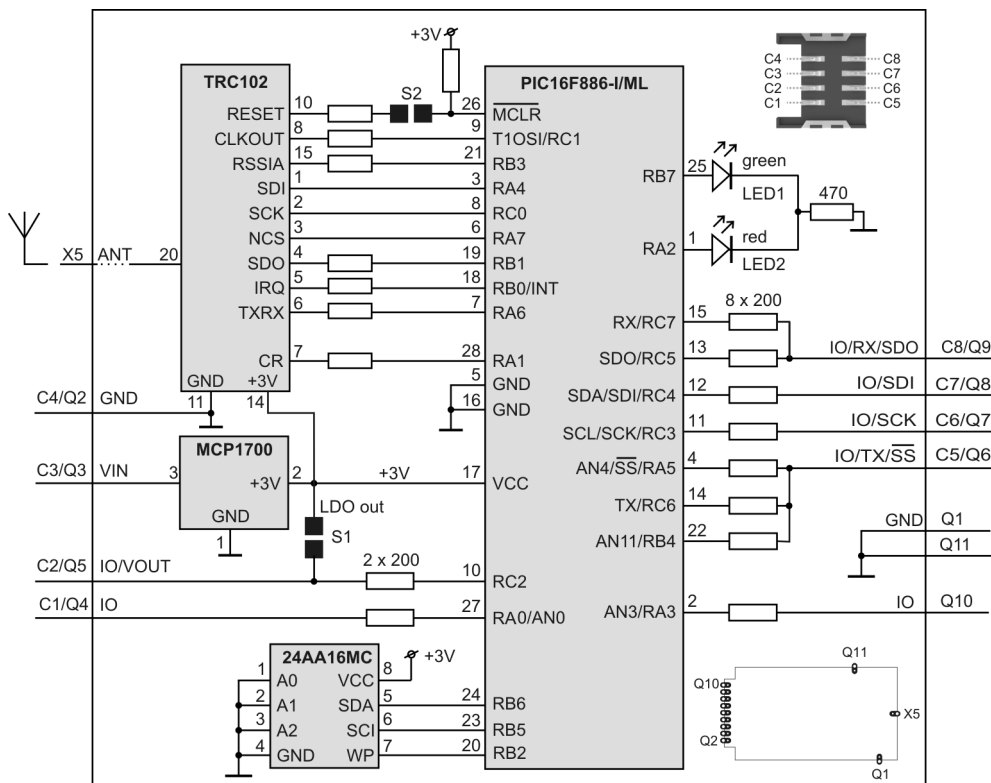

Electrical specifications
(typical values unless otherwise stated, for brief guidance only)

Supply voltage (VCC)	3.0 V to 5.3 V
Operating temperature	0 °C to +70 °C -40 °C to +85 °C (Industrial) available on request
Supply current	
Sleep mode	2 µA
Additional watchdog supply current	2 µA typ., 4 µA max. (watchdog enabled)
Run mode ¹	1 mA @ 8 MHz 170 µA @ 125 kHz 17 µA @ 31 kHz
Additional supply current	0.6 mA (TRC102 on) 2 mA (one or two LEDs on)
Rx mode	13 mA (STD mode) 400 µA (LP mode ⁴) 35 µA max. (XLP mode ⁴)
Tx mode	14 mA – 24 mA (according to RF output power)
RF sensitivity ²	-110 dBm @ 868 MHz, 1.2 kb/s - 99 dBm @ 868 MHz, 19.2 kb/s -109 dBm @ 916 MHz, 1.2 kb/s -102 dBm @ 916 MHz, 19.2 kb/s
RF output power	up to 5 dBm, programmable in 8 steps (7-0), -3dBm/step
RF range (TR-53BA) ³	up to 700 m @ 1.2 kb/s up to 500 m @ 19.2 kb/s
Nominal frequency	868.35 MHz or 916.50 MHz (software selectable)
Channels	See IQRF OS User's guide, Appendix 2, Channel maps
RF data modulation	FSK (frequency-shift-keyed)
RF data transmission bit rate	1.2 kb/s – <i>preliminary</i> 19.2 kb/s 57.6 kb/s – <i>preliminary</i> 86.2 kb/s – <i>preliminary</i>
LDO output (VOUT)	+3 V ± 60 mV, 100 mA max.
A/D converter	10 b, 3 inputs (multiplexed S&H, successive approximation)
Input A/D impedance	10 kΩ max.
Size (L x W x H)	28.4 mm x 14.9 mm x 3.0 mm 33.6 mm x 14.9 mm x 3.0 mm (TR-53BA)

Note 1: TRC 102 in standby mode.

Note 2: RF sensitivity depends on frequency band and bit rate.

Note 3: RF range strongly depends on module orientation and surroundings.

Note 4: Depends on interferences.

Users have to ensure observing local provisions and restrictions relating to the use of short range devices by software, e.g. the CEPT ERC/REC 70-03 Recommendation and subsequent amendments in EU.

Absolute maximum ratings

Stresses above those values may cause permanent damage to the device. Exposure to maximum rating conditions for extended periods may affect device reliability.

Supply voltage (VCC)	5.5 V
Storage temperature	-50 °C to +100 °C
Ambient temperature under bias	-40 °C to +85 °C

Table 1: For more information refer to datasheets of ICs used:

IC	type	manufacturer
MCU	PIC16F886-I/ML	Microchip
RF IC	TRC102	RF Monolithics (RFM)
LDO voltage regulator	MCP1700	Microchip

Pin	Name	Description
C1 Q4	IO/AN RA0 AN0	General I/O pin Analog A/D input
C2 Q5	IO/AN/VOUT RC2 VOUT	General I/O pin (S1 disconnected) On-board +3 V LDO output (S1 connected)
C3 Q3	VIN	Power supply voltage
C4 Q2	GND	Ground
C5 Q6	IO/AN/TX/-SS RA5 -SS AN4 RC6 TX RB4 AN11	General I/O pin, SPI Slave select Analog A/D input General I/O pin UART Tx General I/O pin, wake-up on change Analog A/D input
C6 Q7	IO/SCK/SCL RC3 SCK SCL	General I/O pin SPI clock input I ² C clock
C7 Q8	IO/SDI/SDA RC4 SDI SDA	General I/O pin SPI data I ² C data
C8 Q9	IO/RX/SDO⁵ RC5, RC7 RX SDO	General I/O pin UART Rx SPI data out
Q10	IO/AN RA3 AN3	Antenna input General I/O pin, Analog A/D input
Q1	GND	Ground
Q11	GND	Ground
X5	ANT	Antenna input
P1–P6		For factory programming only
S1		LDO output enable. Connect to enable (default disabled).
S2		TRC102 reset output enable. Connect to reset the MCU from the TRC102 (default disabled).

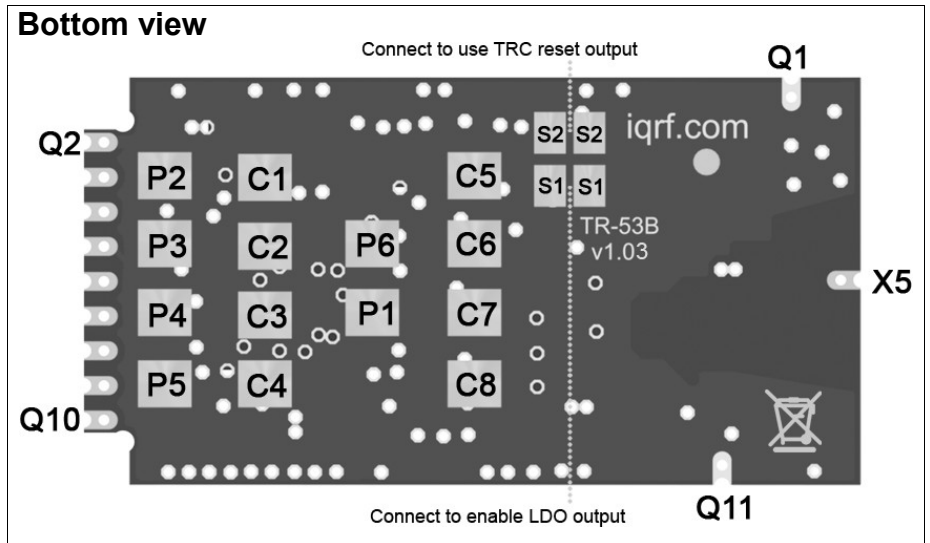

Note 5: This pin is used as output during initial ~250 ms boot-up to recognize programming mode.

Table 2: Relative RF range vs. level for the `setTXpower(level)` function. Refer to IQRF OS Reference guide.

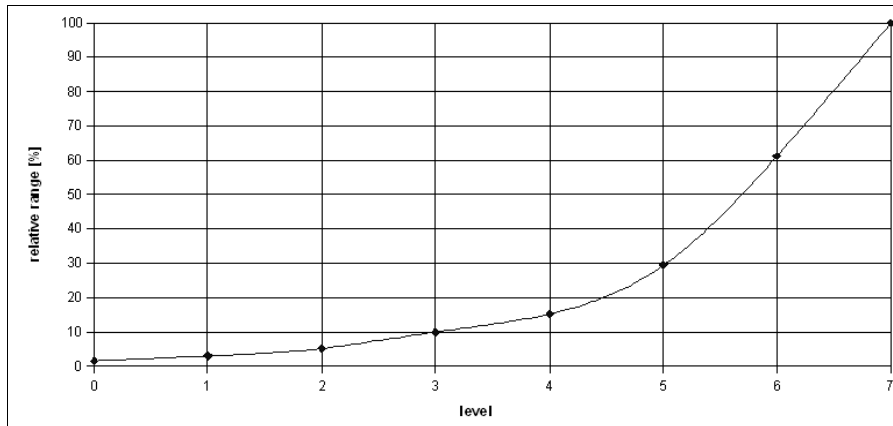
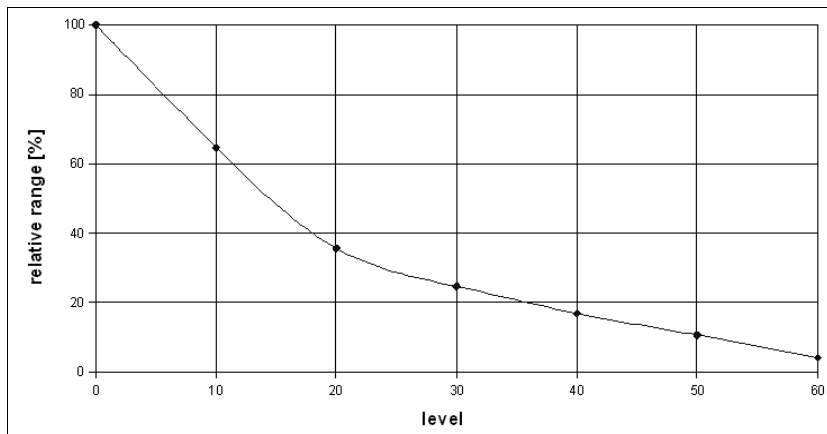

Table 3: Relative RF range vs. level for the `checkRF(level)` detection. Refer to IQRF OS Reference guide.



Application

See IQRF OS User's guide, IQRF OS Reference guide, Application examples and www.iqrf.org.

Dimensions

TR-53B, TR-53BC

Top view, units: mm

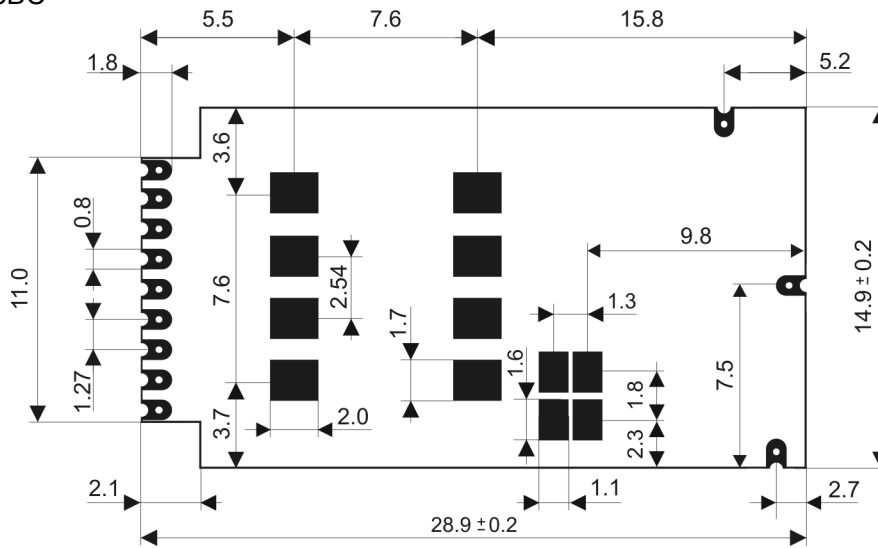

TR-53BA

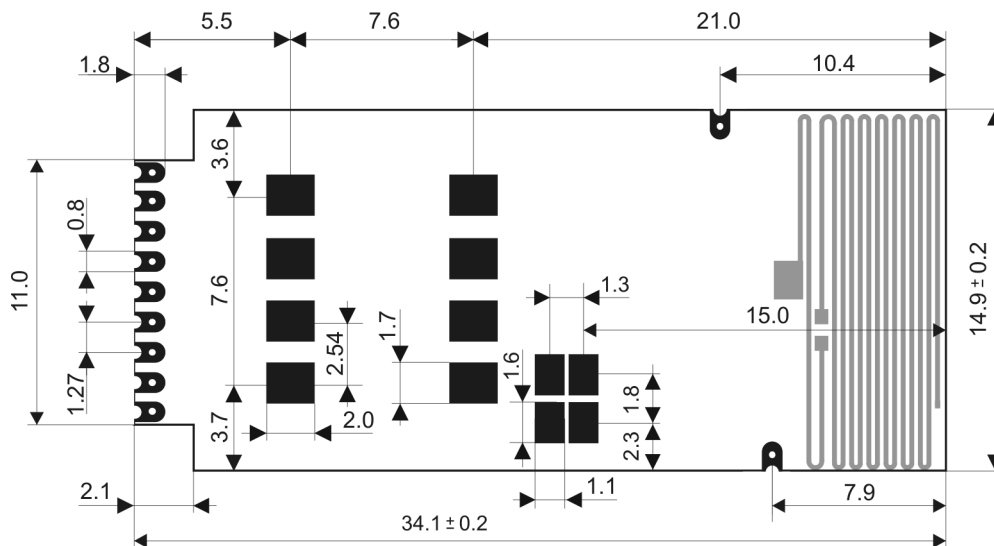

Mounting

The module is designed to be mounted:

- Via the SIM connector. Recommended type: KON-SIM-01.
- Horizontally with soldering pads (SMT).
- Vertically through a slot in the main board, pads soldered from the bottom. Double layer PCB with metallized holes are recommended otherwise the module should be glue fixed from the top.

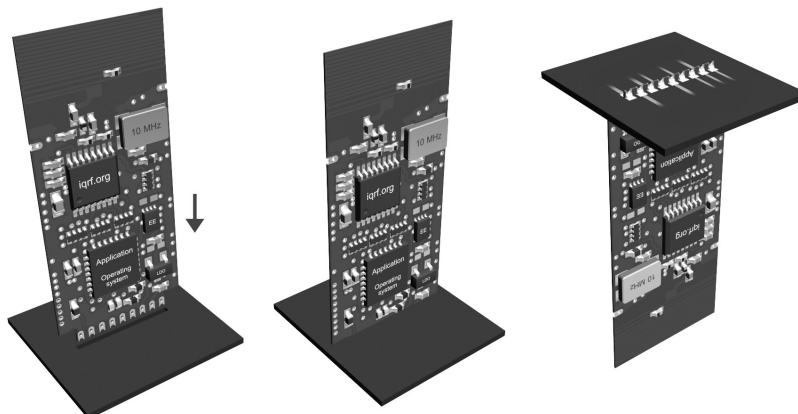

Recommended PCB footprint

Horizontal mounting

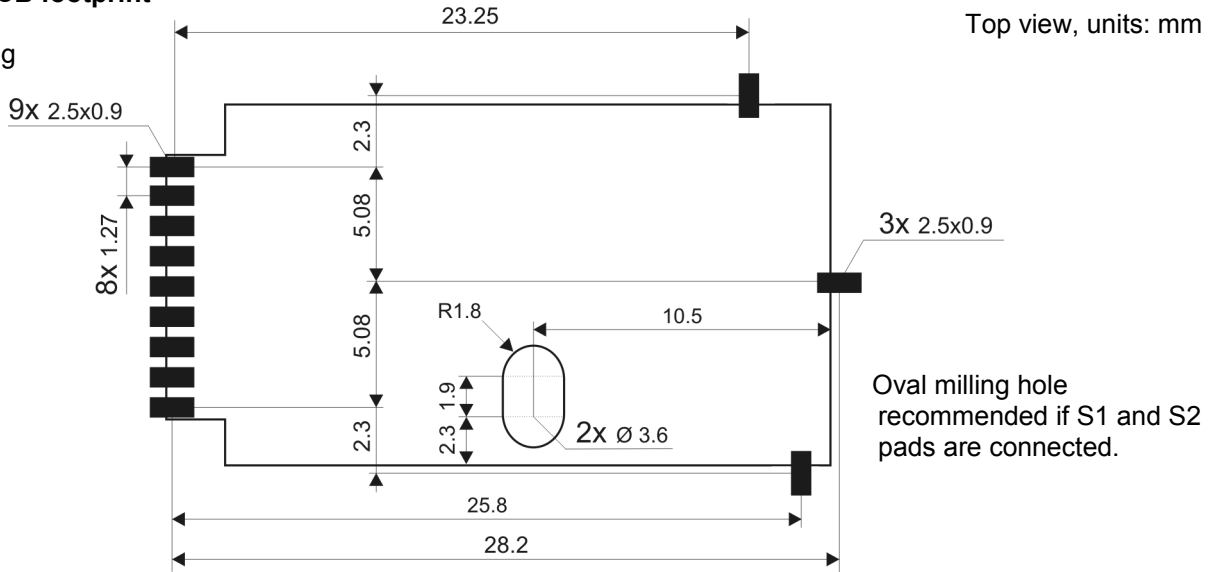

Vertical mounting
PCB slot 1 x 11.2
single layer PCB
glue fixing

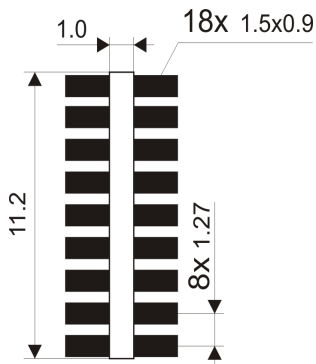

Vertical mounting
PCB slot 1 x 11.2
double layer PCB
metallized holes

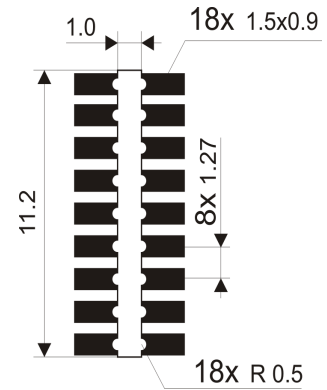

Conductive areas close to the integrated antenna must be avoided. Recommended minimal spacing is 10 mm.

Table 4: Relative decrease of RF input signal vs. antenna edge spacing to conductive areas:

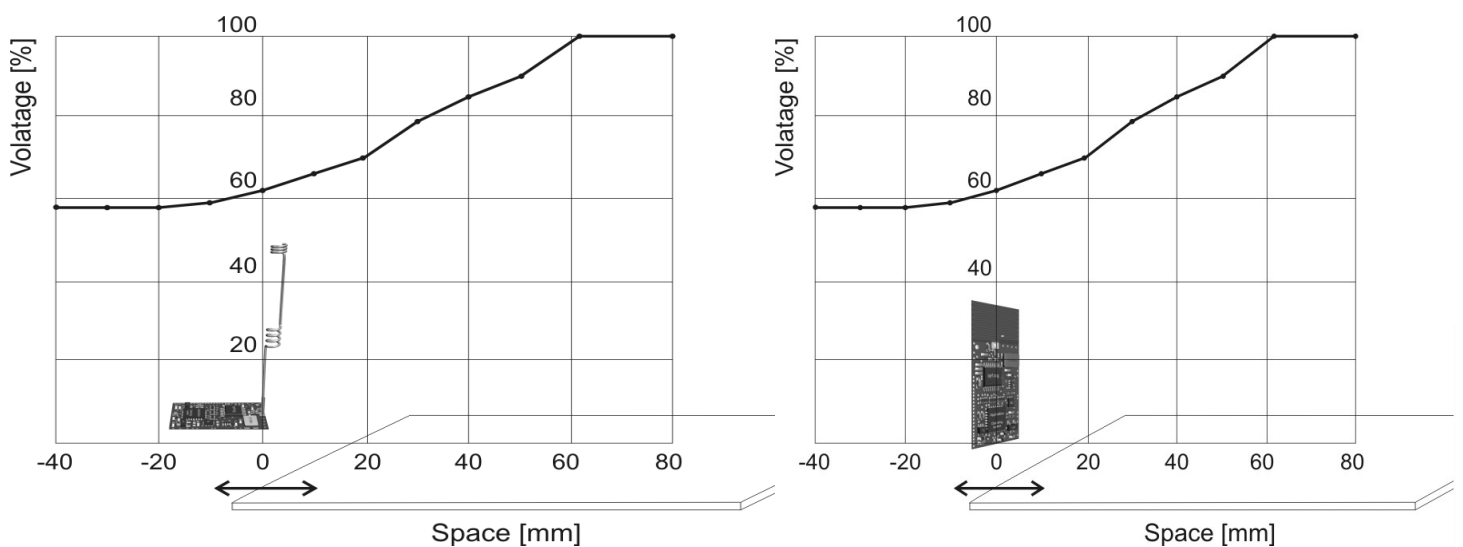

Ordering codes

Type	frequency [MHz]	antenna connector
TR-53B	868 / 916	soldering hole
TR-53BC	868 / 916	KON-U.FL-R-SMT (mini coax) for AN-05-C or CAB-U.FL
TR-53BA	868 / 916	built-in PCB antenna

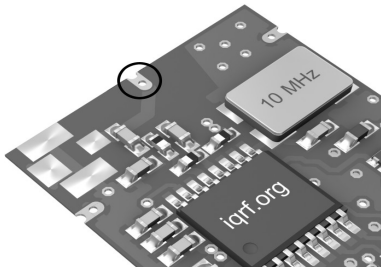

TR-53B

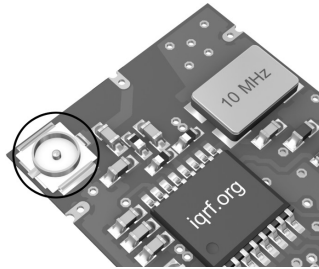

TR-53BC

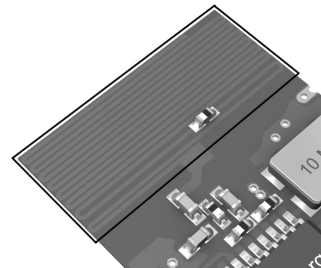

TR-53BA

Document history

- 110124 Power consumption updated for IQRF OS v3.00. Recommended PCB footprint corrected.
- 100601 First release

Sales and Service

Corporate office

MICRORISC s.r.o., Delnicka 222, 506 01 Jicin, Czech Republic, EU
Tel: +420 493 538 125, Fax: +420 493 538 126, www.microrisc.com

Partners and distribution

Please visit www.iqrf.org/partners

Quality management

ISO 9001 : 2000 certified

*Complies with ETSI directives EN 30279 V.1.2.1:99, ETS 30683:97, ETSI EN 301489-1:00,
ETSI EN 300220-1:00, ETSI EN 300390-2V.1.1.1:00*

Complies with FCC directives FCC CFR, Title 47, Part 15, Section 15.209, FCC CFR, Title 47, Part 15, Section 15.249

Complies with Directive 2002/95/EC (RoHS)



Trademarks

*The IQRF name and logo are registered trademarks of MICRORISC s.r.o.
PIC, SPI, Microchip, RFM and all other trademarks mentioned herein are property of their respective owners.*

Legal

All information contained in this publication is intended through suggestion only and may be superseded by updates without prior notice. No representation or warranty is given and no liability is assumed by MICRORISC s.r.o. with respect to the accuracy or use of such information.

Without written permission it is not allowed to copy or reproduce this information, even partially.

No licenses are conveyed, implicitly or otherwise, under any intellectual property rights.

The IQRF products utilize several patents (CZ, EU, US)

On-line support: <http://iq-esupport.com>



Simple way to smarter wireless solutions