

TR-52D

Transceiver Module

Data Sheet



Description

TR-52D is a family of IQRF transceiver modules operating in the 868 MHz and 916 MHz license free ISM (Industry, Scientific and Medical) frequency band. Its highly integrated ready-to-use design requires no external components. Microcontroller with built-in operating system, excellent development support, integrated LDO regulator, serial EEPROM and optional temperature sensor dramatically reduce time of application development. Ultra low power consumption predetermines these modules for use in battery powered applications.

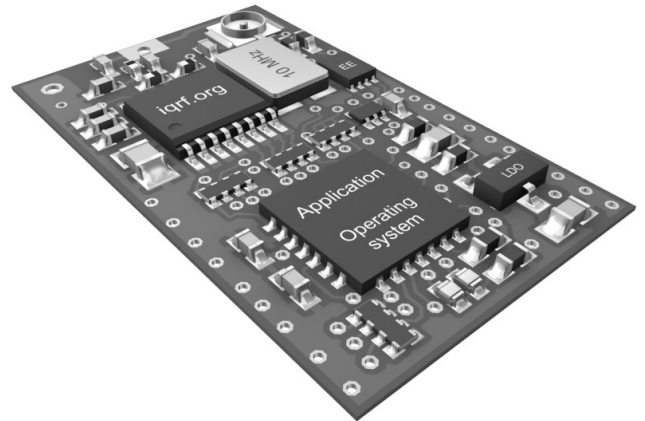

Applications

- Telemetry
- Building automation
- Wireless control & regulation
- Access control
- Remote data acquisition
- Communication links
- RF connectivity in many other areas

Key features

- Complete solution with operating system, easy to use
- Extended RF power, FSK modulation, selectable RF bit rate
- Selectable band 868 / 916 MHz, multiple channel
- MCU with extended resources
- Ultra low power consumption, power management modes
- SPI interface supported by OS on background
- +3 V LDO regulator output, battery monitoring
- 2 LEDs
- Up to 6 I/Os, 2 analog inputs (A/D)
- Options: on-board antenna, U.FL connector and temperature sensor
- SIM card format

Simplified schematics

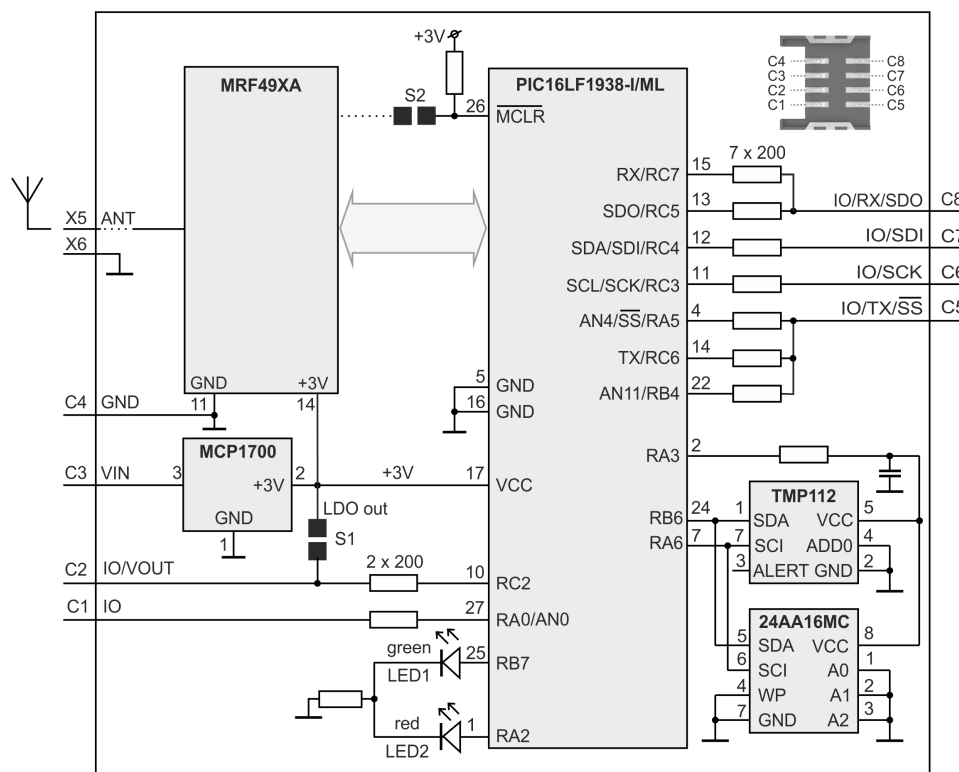

Electrical specifications
(typical values unless otherwise stated, for brief guidance only)

Supply voltage (V_{CC})	3.1 V to 5.3 V
LDO output (V_{OUT})	+3 V \pm 60 mV ($V_{CC} > 3.1$ V), 100 mA max.
Operating temperature	0 °C to +70 °C -40 °C to +85 °C (Industrial) available on request
Supply current	
Sleep mode	2 μ A
Additional watchdog supply current	1 μ A (if watchdog enabled)
Run mode	
MRF49XA in standby mode	1 mA
MRF49XA on	1.6 mA
Additional LED supply current	2 mA (if one or two LEDs on)
Rx mode	13 mA (STD mode) 400 μ A (LP mode ³) 35 μ A max. (XLP mode ³)
Tx mode	14 mA – 24 mA (according to RF output power)
RF sensitivity ¹	-110 dBm @ 868 MHz, 1.2 kb/s -99 dBm @ 868 MHz, 19.2 kb/s -109 dBm @ 916 MHz, 1.2 kb/s -102 dBm @ 916 MHz, 19.2 kb/s
RF output power	up to 5 dBm, programmable in 8 steps (7 – 0), -3dBm/step
RF range (TR-52DA) ²	up to 850 m @ 1.2 kb/s up to 650 m @ 19.2 kb/s
Frequency bands	868.35 MHz or 916.50 MHz (software selectable)
Channels	See IQRF OS User's guide, Appendix 2, Channel maps
RF data modulation	FSK (frequency-shift-keyed)
RF data transmission bit rate	1.2 kb/s – preliminary 19.2 kb/s 57.6 kb/s – preliminary 86.2 kb/s – preliminary
Input voltage on C1, C2, C5 to C8 pins	0 V to V_{OUT}
A/D converter	10 b, 2 inputs (multiplexed S&H, successive approximation)
Input A/D impedance	10 k Ω max.
Temperature sensor accuracy	0.5°C max. (0°C to +65°C)
Size (L x W x H)	25.0 mm x 14.9 mm x 3.0 mm 31.8 mm x 14.9 mm x 3.0 mm (TR-52DA)

Note 1: RF sensitivity depends on frequency band and bit rate.

Note 2: RF range strongly depends on module orientation and surroundings.

Note 3: Depends on interferences.

Users have to ensure observing local provisions and restrictions relating to the use of short range devices by software, e.g. the CEPT ERC/REC 70-03 Recommendation and subsequent amendments in EU.

Absolute maximum ratings

Stresses above those values may cause permanent damage to the device. Exposure to maximum rating conditions for extended periods may affect device reliability.

Supply voltage (V_{CC})	5.5 V
Voltage on C1, C2, C5 to C8 pins	-0.3 V to ($V_{OUT} + 0.3$ V)
Storage temperature	-50 °C to +100 °C
Ambient temperature under bias	-40 °C to +85 °C

Table 1: For more information refer to datasheets of ICs used:

IC	type	manufacturer	note
MCU	PIC16LF1938-I/ML	Microchip	
RF IC	MRF49XA	Microchip	
LDO voltage regulator	MCP1700	Microchip	
Temperature sensor	TMP112	Texas Instruments	TR-52DT, TR-52DCT and TR-52DAT only
EEPROM	24AA16/MC	Microchip	

Pin	Name	Description
-----	------	-------------

C1	IO/AN RA0 AN0	General I/O pin Analog A/D input
C2	IO/AN/VOUT RC2 VOUT	General I/O pin (S1 disconnected) On-board +3 V LDO output (S1 connected)
C3	VIN	Power supply voltage
C4	GND	Ground
C5	IO/AN/TX/-SS RA5 -SS AN4 RC6 TX RB4 AN11	General I/O pin, SPI Slave select Analog A/D input General I/O pin UART TX General I/O pin, wake-up on change Analog A/D input
C6	IO/SCK/SCL RC3 SCK SCL	General I/O pin SPI clock input I ² C clock
C7	IO/SDI/SDA RC4 SDI SDA	General I/O pin SPI data I ² C data
C8	IO/RX/SDO⁵ RC5 SDO RC7 RX	General I/O pin SPI data out General I/O pin UART RX
X5	ANT	Antenna input
X6	GND	Ground
P1–P5		For factory programming only
S1		LDO output enable. Connect to enable (default disabled).
S2		Leave disconnected.

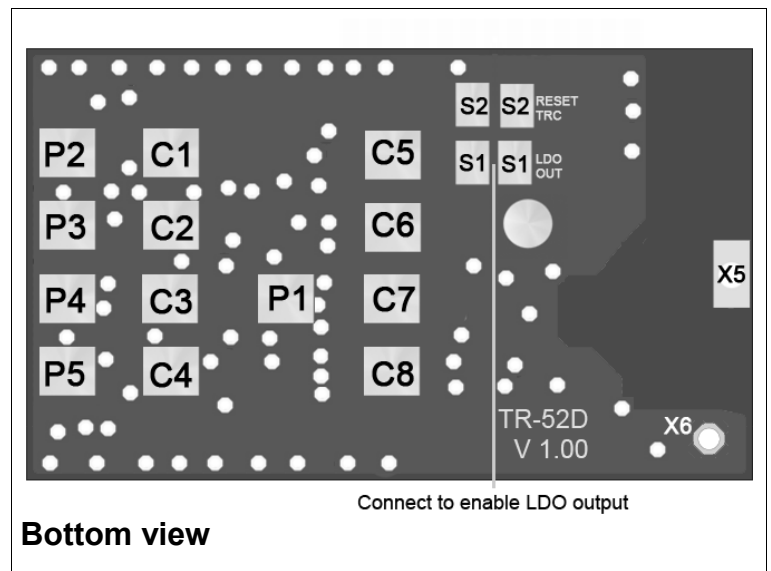

Note 5: This pin is used as output during initial ~250 ms boot-up to recognize programming mode.

Application

See IQRF OS User's guide, IQRF OS Reference guide, Application examples and www.iqrf.org.

Table 2: Relative RF range vs. level for the `setTXpower(level)` function. Refer to IQRF OS Reference guide.

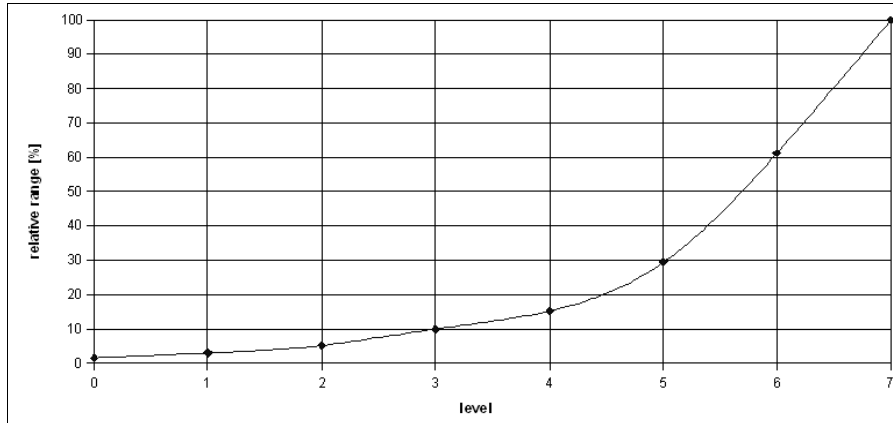

Table 3: Relative RF range vs. level for the `checkRF(level)` detection. Refer to IQRF OS Reference guide.

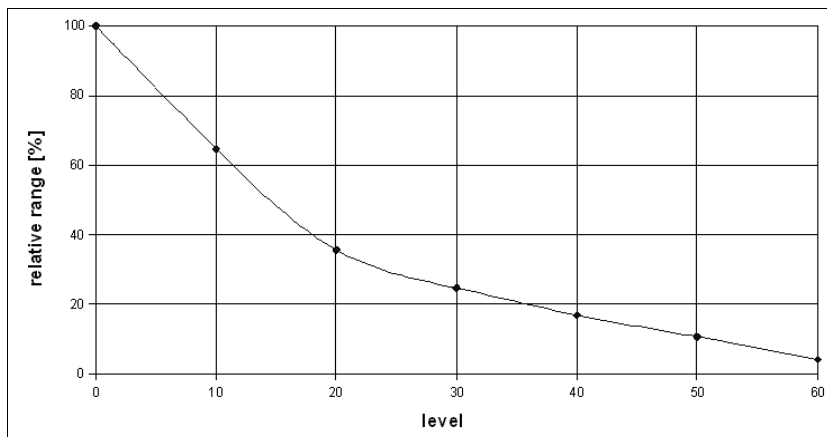

Figure 4: Relative RF range vs. antenna orientation (radiation patterns)

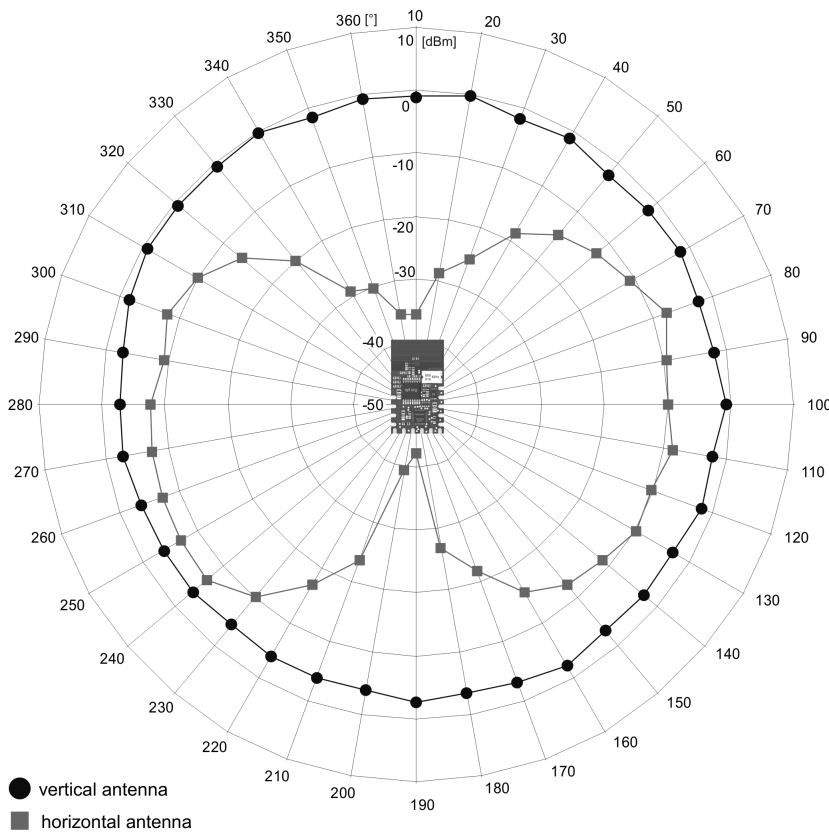
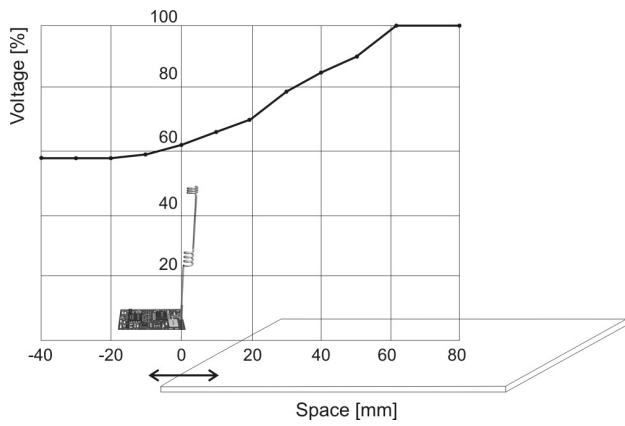

Table 5: Relative decrease of RF input signal vs. antenna edge spacing to conductive areas.



Conductive areas close to the antenna must be avoided. Recommended minimal spacing is 10 mm.

Dimensions

TR-52D(C)(T)(E)

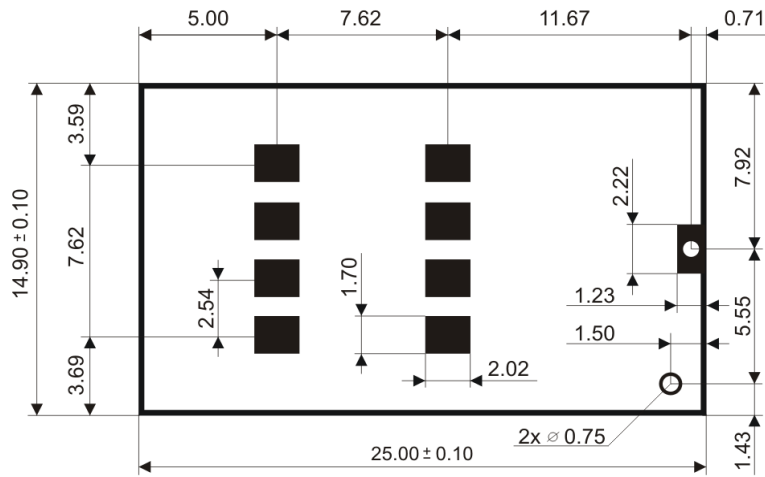

TR-52DA(T)(E)

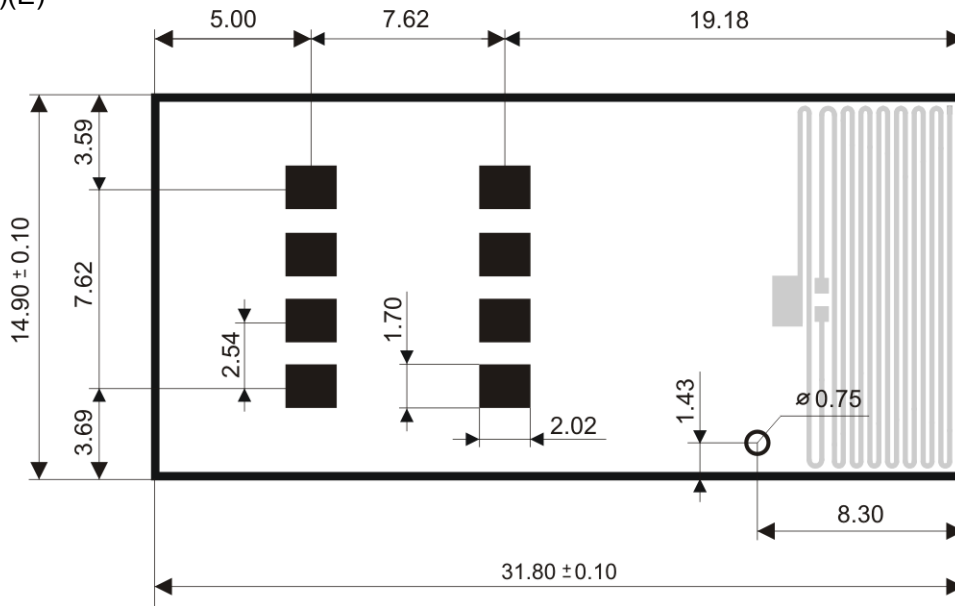

Units: mm

Recommended SIM connector: KON-SIM-01

Product information

Ordering codes

T R - 5 2 D A PP

- peripheral options: **ni1** - no serial EEPROM, no temperature sensor
- T** - temperature sensor
- E** - serial EEPROM
- antenna options: **ni1** - soldering hole (no antenna, no U.FL connector)
- A** - PCB antenna,
- C** - U.FL connector (mini coax)

Examples:

Type	Antenna connection	Temperature sensor	Serial EEPROM
TR-52D	Soldering hole	-	-
TR-52DC	U.FL connector	-	-
TR-52DA	PCB antenna	-	-
TR-52DT	Soldering hole	Yes	-

Type	Antenna connection	Temperature sensor	Serial EEPROM
TR-52DE	Soldering hole	-	Yes
TR-52DCE	U.FL connector	-	Yes
TR-52DCTE	U.FL connector	Yes	Yes
TR-52DATE	PCB antenna	Yes	Yes

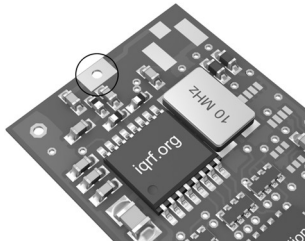

TR-52D

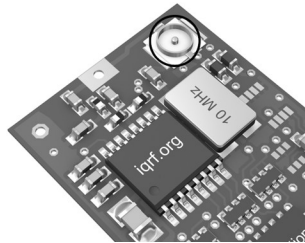

TR-52DC

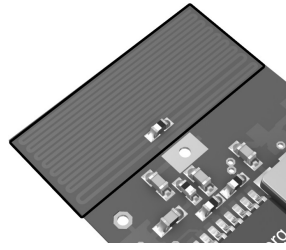

TR-52DA

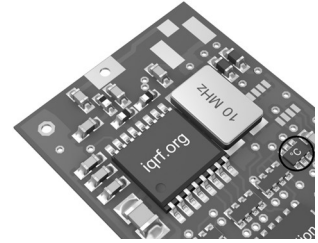

TR-52DT

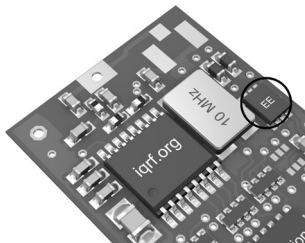

TR-52DE

Document history

- 120425 RF range specified.
- 120322 Slightly improved. Fig. 4 added. Preliminary.
- 111011 Temperature sensor available optionally. Preliminary.
- 110919 Preliminary

Sales and Service

Corporate office

MICRORISC s.r.o., Delnicka 222, 506 01 Jicin, Czech Republic, EU
Tel: +420 493 538 125, Fax: +420 493 538 126, www.microrisc.com

Partners and distribution

Please visit www.iqrf.org/partners

Quality management

ISO 9001 : 2009 certified

*Complies with ETSI directives EN 30279 V.1.2.1:99, ETS 30683:97, ETSI EN 301489-1:00,
ETSI EN 300220-1:00, ETSI EN 300390-2V.1.1.1:00*

Complies with FCC directives FCC CFR, Title 47, Part 15, Section 15.209, FCC CFR, Title 47, Part 15, Section 15.249

Complies with Directive 2002/95/EC (RoHS)



Trademarks

*The IQRF name and logo are registered trademarks of MICRORISC s.r.o.
PIC, SPI, Microchip, RFM and all other trademarks mentioned herein are property of their respective owners.*

Legal

All information contained in this publication is intended through suggestion only and may be superseded by updates without prior notice. No representation or warranty is given and no liability is assumed by MICRORISC s.r.o. with respect to the accuracy or use of such information.

Without written permission it is not allowed to copy or reproduce this information, even partially.

No licenses are conveyed, implicitly or otherwise, under any intellectual property rights.

The IQRF products utilize several patents (CZ, EU, US)

On-line support: support@iqrf.org



Smarter wireless. Simply.